

Adaptive Monitoring and Localization of Faulty Node in a Wireless Sensor Network

James Agajo^{a*}, Okhaifoh J.^b, Onyebuchi Nosiri^c, Ekwueme Emmanuel Uchenna^d

^aFederal University of Technology Dept. of Computer Engineering, P.M.B 65 Minna Nigeria

^bFederal University of Petroleum Resources Effurun Delta State Nigeria

^{c,d}Dept of Electrical/Electronic, Federal University of Technology Owerri Imo State Nigeria

^aEmail: agajojul@gmail.com

Abstract

This work seeks to solve the problem that is being experienced in most existing remote monitoring systems by coming up with an enhanced monitoring system called Wireless Sensor Network. A Personal Area Network was evolved to increase the coverage area by spatially distributing Sensor nodes to capture and transmit physical parameters like temperature and Carbon monoxide in an indoor local cooking environment. Faulty node detection and localization was also realized, this was achieved by coming up with an algorithm that logically considers the receive signal strength value of -100 dbm as threshold, Result of data transmitted were viewed via a C-Sharp interface for Adaptive monitoring. The result from the Visual Basic plot shows that the Sensor nodes were able to capture temperature range of between 25⁰C to 51⁰C while the result of the CO emission shows an interval of 0.01g/m³ to 30.0 g/m³. A comparison between data transmitted at source and data received at the destination (sink) was carried out, a ranking test was used to validate the data received, a 0.9325 correlation value was obtained which shows a high level of integrity of 93.25% .

Keyword: WSN; Faulty node; Adaptive Monitoring; Data Acquisition.

1. Introduction

Recent advances in wireless communications and microelectro-mechanical systems have motivated the development of extremely small, low-cost sensors that possess sensing, signal processing and wireless communication capabilities.

* Corresponding author.

E-mail address: agajojul@gmail.com.

The accuracy of individual nodes' readings is crucial in these applications, e.g., in a surveillance network in figure 1 and 2 [8], the readings of sensor nodes must be accurate to avoid alert and missed detections. Although some applications are designed to be fault tolerant to some extent, removing nodes with faulty readings from a system with some redundancy or replacing them with good ones can still significantly improve the whole system's performance and at the same time prolong the lifetime of the network [4].

Most distributed monitoring networks are saddled with the following problems [5].

- i. Low coverage Area
- ii. Faulty Node Detection
- iii. Dynamic real time graph plotter

In enhancing area of coverage more sensor are needed but this increased number will give rise to possibility of faulty nodes, the need for faulty node detection hence becomes necessary.

Since wireless sensors are deployed in hazardous terrains, the tendency for failure is high, due to these conditions; possibility of failed sensors is imminent. It is important and necessary to study the fault detection methods for nodes in WSNs for obvious reasons.

For area with large number of sensors it is obvious that data might be lost due to lack of flexibility.

2. Objective

The main objective of the research is to realize an enhanced faulty node location monitoring system in a spatially distributed autonomous sensors used in monitoring environmental parameters, like temperature and Carbon Monoxide [10, 11].

- i. Faulty node detection and localization.
- ii. Adaptive monitoring with the aid of dynamic Graph Plotter

3. Temperature Sensor

Temperature is one of the most frequently measured physical characteristics in measurement science. Nowadays the measurement of temperature can be detected with a satisfactory accuracy. State-of-the-art miniaturized temperature sensors can be classified by different principles, e.g., resistive-, thermoelectric-, radial-, optical-, PN junction, quartz resonator- techniques. The resistive and thermoelectric sensors are the most common among them, but the two types of sensors output analogue signal directly and need A/D Converter on the back end. Fortunately, MCU in the sensor node frequently integrates A/D converter, thus it is easy for temperature sensors with analogue output to integrate in sensor nodes. One of the variables to be measured using Wireless Sensors is Pollution from Carbon emission.

4. Localization

Sensor Node localization is a fundamental and crucial issue for network management and operation. In many of the real world scenarios, the sensors are deployed without knowing their positions in advance and also there is no supporting infrastructure available to locate and manage them, once they are deployed.

Determining the physical location of the sensors after they have been deployed is known as the problem of localization [6,7,15,16].

Location discovery or localization algorithm for a sensor network should satisfy the following requirements:

1) The localization algorithm should be distributed since a centralized approach requires high computation and nodes to estimate the position of nodes in the whole environment. This increases signaling bandwidth and also puts extra load on nodes close to center node [17,18].

3) Localization algorithms should be robust enough to localize the failures and loss of nodes. It should be tolerant to error in physical measurements.

4) Techniques that depend on measuring the ranging information from signal strength that is typically not available on sensor nodes.

6) Localization algorithm should be accurate, scalable and support mobility of nodes [19,20,21].

5. Test bed

The map obtained from Microsoft visual map shows the various sites where the sensor nodes were being deployed in figure 1 and 2, the average inter-sensor node distance was 60 meter. The signal level was not measured with attitude in the map, but basically the level of strength in signal and surface put together should make up for that to some extent, but from the observation the signal strength level was not uniform with inter sensor surface as a result of difference in altitude. Signal was still strong enough to be received and also be transmitted. Figure 1 and figure 2 shows a map of some areas where the wireless smart nodes were deployed, one main limitation was that this work did not take into account the impact of altitude or non-evenness in the landscape in measuring intersensor distance with respect to signal strength.

6. System Analysis and Method

This research employed Software design approach, Software tools were used to realize this work, Software like; VB.NET, ORACLE, SQL Database, C-SHARP, PROTEUS LABORATORY and ATMEL AVR were used in Designing program for the Software interface [22,23,24].

Since a large number of battery-driven nodes are deployed in a WSN, energy efficiency, fault tolerance, scalability would be taken into account in designing WSN architecture [1,25,26].



Figure 1: Map area of deployment of Wireless Sensor nodes Test bed 2

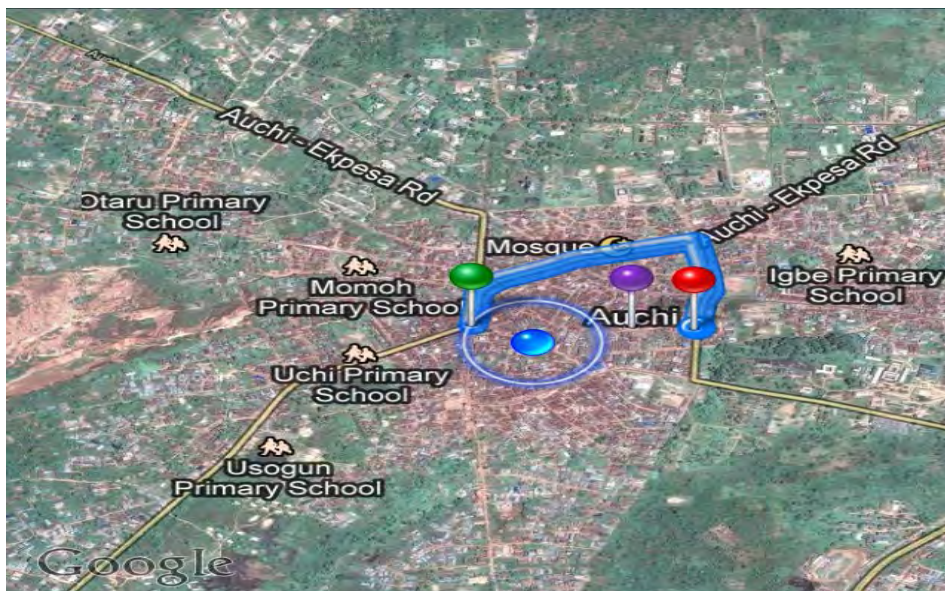

Figure2: Map area of deployment of Wireless Sensor nodes Test bed 2

Therefore, we need a WSN architecture which satisfies requirements for both normal and emergency conditions. There have been a lot of excellent works on data gathering schemes which can be applied in normal situations, for example, [9]. We take an approach to incorporate mechanisms for urgent information transmission with any data gathering scheme well-designed for application-oriented communication [28,29,30].

It means that a WSN operates on a data gathering scheme in the normal situation. Once an emergency occurs with regard a node going faulty, an appropriate series of actions take place to deliver urgent information to the Base Station. inter node data transmission is made possible by the node addressing, that is for data to be transmitted between nodes their respective addresses and their payload will be noted, thereby arranging the node in the network to follow a particular routing protocol, a particular route is characterized by column which is the PAN (Personal area network) , while the row represent the next route.

The node in the row will involve picking on the nodes column after column in a particular row that is $R_{11}, R_{12}, \dots, R_{1n}$, while the last row will involve $R_{m1}, R_{m2}, \dots, R_{mn}$.

Column = inner loop while

row = outer loop

The recursive equation for the inner loop which stand for the column will be the first to be executed before that of the outer loop which is the row as represented by equation 1

$$\text{Inner loop} = \sum_{i=1}^n R_i \dots \dots (1)$$

$$\text{outer loop} = \sum_{j=1}^m R_j \dots \dots (2)$$

R_j is node parameter like data and address

overall nodes in the network =

$$\sum_{\substack{j=1 \\ i=1}}^{nm} R_{mn} \dots \dots (3)$$

6.1 Artificial Neural Network Application

We come up with a design where the data is a function of weight w and input value x

- $X_1 - W_1$
- $X_2 - W_2$
- ·
- ·
- $X_n - W_n$

A forward propagation technique will require a transition for the neural set for inter-node communication, considering the values of x as input value and was weight.

Which therefore express the process of data transmission between nodes as

$$\begin{aligned} &X_{11}W_1 - X_{12}W_2 - X_{13}W_3 \dots \dots X_{1n}W_n \\ &X_{21}W_1 - X_{22}W_2 - X_{23}W_3 \dots \dots X_{2n}W_n \\ &X_{31}W_1 - X_{32}W_2 - X_{33}W_3 \dots \dots X_{3n}W_n \dots (4) \\ &\cdot \qquad \qquad \qquad \cdot \end{aligned}$$

$$X_{m1}W_1 - X_{m2}W_2 - X_{m3}W_3 \dots\dots\dots X_{mn}W_n$$

A summary of the equation is

$$F_{net} = w_1x = w_1x_1 + \dots + \dots w_nx_n \dots (3.5)$$

This work refer to reduced functional device RFD as the source and intermediary node which is the input and the full functional device FFD as the sink, we therefore substitute the input x in the neural set as R while FFD is substituted for F as shown in figure 3.

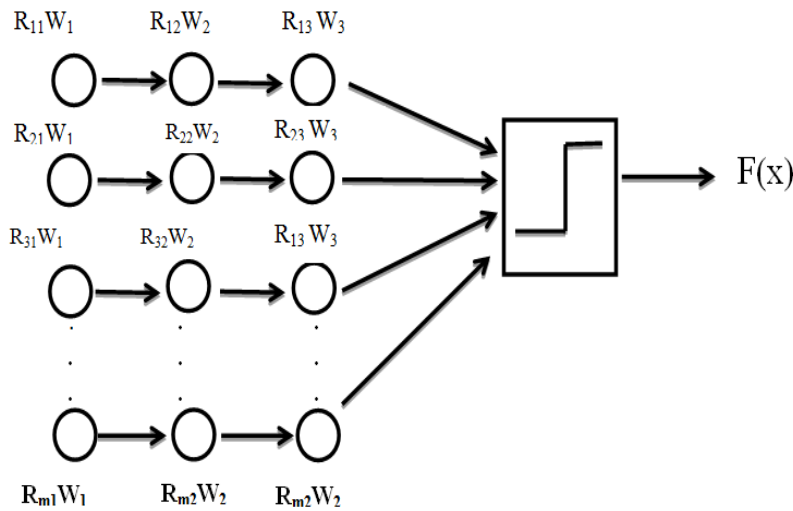

Figure 3: Recurrent Neural Network Model for WSN

R = RFD

F = FFD

We refer data from RFD as R

$$X = R$$

$$\begin{matrix} R_{11}W_1 - R_{12}W_2 - R_{13}W_3 \dots\dots\dots R_{1n}W_n \\ R_{21}W_1 - R_{22}W_2 - R_{23}W_3 \dots\dots\dots R_{2n}W_n \\ R_{31}W_1 - R_{32}W_2 - R_{33}W_3 \dots\dots\dots R_{3n}W_n \\ \cdot \quad \quad \quad \cdot \quad \quad \quad \cdot \\ \cdot \quad \quad \quad \cdot \quad \quad \quad \cdot \\ \cdot \quad \quad \quad \cdot \quad \quad \quad \cdot \\ R_{m1}W_1 - R_{m2}W_2 - R_{m3}W_3 \dots\dots\dots R_{mn}W_n \end{matrix}$$

The neural set above directly substitute x for R the matrix represent the solution for the equation in figure....

The Matrix in the equation which can then be expressed as logistic regression in figure 4 note this model is only implementable when the addressing mode is perfect for a linear routine process.

The neural network will look like this, it is a feed forward senerio , the first column is the input R with its corresponding weight w , followed by the repeater node which is referred to as intermediate node, they could also be termed as hidden layers, which ranges between 1,l and L as shown in figure 5.

$$\begin{bmatrix} R_{11} & R_{12} & R_{13} & \dots & R_{1n} \\ R_{21} & R_{22} & R_{23} & \dots & R_{2n} \\ R_{31} & R_{32} & R_{33} & \dots & R_{3n} \\ \vdots & \vdots & \vdots & \ddots & \vdots \\ R_{m1} & R_{m2} & R_{m3} & \dots & R_{mn} \end{bmatrix} \begin{bmatrix} W_1 \\ W_2 \\ W_3 \\ \vdots \\ W_n \end{bmatrix} = \begin{bmatrix} F_1 \\ F_2 \\ F_3 \\ \vdots \\ F_n \end{bmatrix}$$

Figure 4: Neural Network Matrix for WSN

$$1 \leq l \leq L, \text{ layers}$$

Which can be represented with a black box

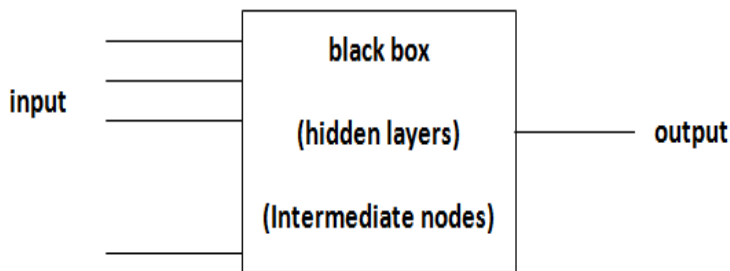

Figure 5: Black box for hidden layers (intermediary node)

This is logistic regression they have the same structure like the linear model, where we have the input combined linearly using weight sum up into a signal which passes soft threshold.

The eventual equation becomes

$$F(R) = F_{NN}(R-1),y(R-2),y(R-3)..y(R-n) \dots(5)$$

This shows how data is routed from one node to another.

6.2 Faulty node localization

6.2.1 Algorithms

The faulty node localization Algorithm is determined. One start by dimensioning all the nodes, the Sensor nodes signal strength level (RSS) is noted. The receiver in the sink node constantly monitors the Sensor Nodes Signal level, The location address is also read, The Node Signal Strength is constantly checked and once it goes below -100dBm . It compares the address of the transmitting node with that of the one in the database. The statement

$n = n - 1$ is to check for failed nodes and also trace its location. Green and red objects can be used to display information on node that is not healthy as designed using the C Sharp software.

The program is made to override green on red for healthy node and red over green for failed node.

Start

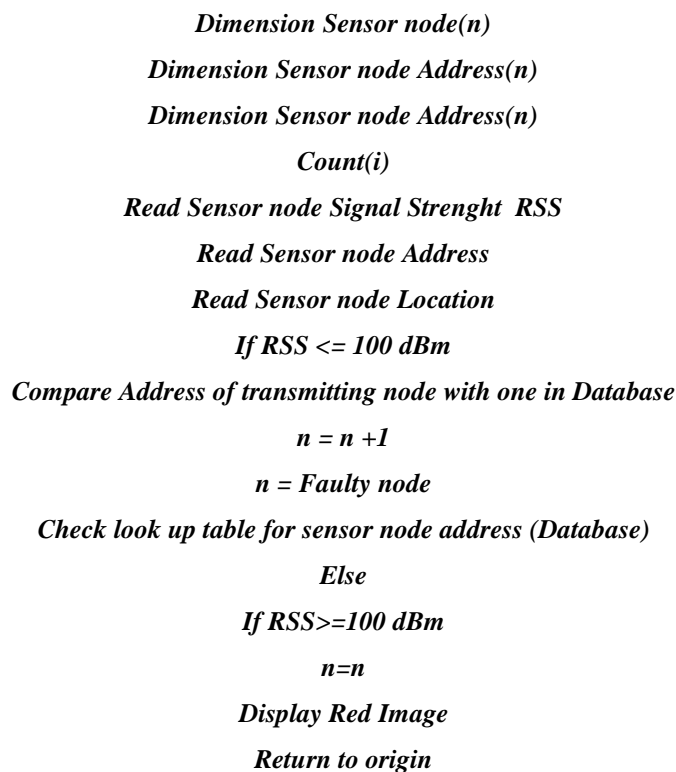

Figure 6: Faulty Node Localization Algorithm

6.3 Node localization

In realizing faulty Node Detection and localization, this work developed an approach that compares signal level of the sensor nodes, when the signal level falls below a predefined level it then calls the database, the real-time faulty node detection was adopted as one did not interface our geographical map to the satellite in space since

that option will not follow real-time.

The images in figure 5 and 6 are figures that represents the ON or OFF state to show node location and their states.

Implementing the faulty nodes requires images converted to objects before codes will be generated.

Since we are using an Object Oriented Programming approach , each image is assigned a sub-routine, the idea is when a node is healthy the sub-routine that links the healthy nodes with the green colour is called , when a node goes bad the sub-routine that links red image is called.

The flowchart in figure 7 is used in realizing localization of faulty node algorithm

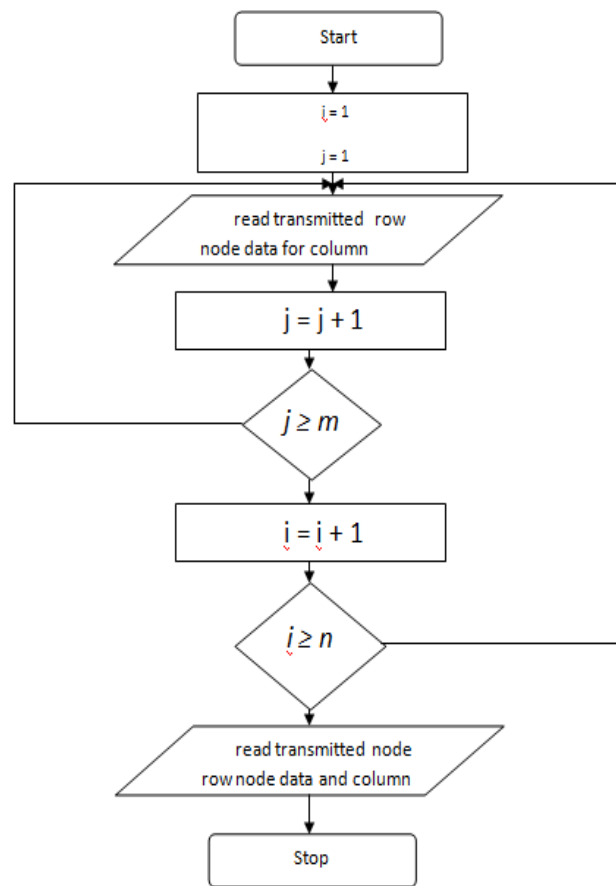

Figure 7: Flowchart showing routing for checking column and row in WSN matrix arrangement

Table 1 and 2 are data been sensed and transmitted from 3 different sensors , note the sequence of data flow in table 2, there was a break in sensor 3 , one outstanding feature in the component of time , one can note the time the node failed by tracing the time the sequence of data generation stopped with respect to time for Sensor 3 in table 2.

Table 1: Data Sensed by Sensor Nodes, day 1 (february 2nd. 2012)

SN	SENSOR 1	SENSOR 2	SENSOR 3
06.00	0.1222901142387+02	0.1223048880450+01	0.1477380630341D-03
07.00	0.1507980352553+02	0.1508497647121+01	0.5172945686114D-03
08.00	0.1894251391813+02	0.1895765122854+01	0.1513731041409D-02
09.00	0.2460382773866+02	0.2464962756723+01	0.4579982856682D-02
10.00	0.3391873333485+02	0.3408223442336+01	0.1635010885070D-01
11.00	0.5248451742415+02	0.5331855223459+01	0.8340348104371D-01
12.00	0.1069156363364+02	0.1168137380031+02	0.9898101666695D+00
12.00	0.5993762963300+02	-.6847966834558+02	-.1284172979786D+03
13.00	0.3675614567764+02	-.8687629546482+01	-.3675701444059D+06
14.00	0.1371434973316+02	-.4588037824984+01	-.1371434973316D+36

Table 2: Data Sensed by Sensor Nodes, DAY 2 (FEBRUARY 3RD. 2012)

CARBON MONOXIDE

SN	SENSOR 1	SENSOR 2	SENSOR 3
15.00	0.1223048913837D+01	0.1223048880450+01	0.3338691878518-07
16.00	0.1508496167191D+01	0.1508497647121+01	0.1479930124670-05
17.00	0.1895754160233D+01	0.1895765122854+01	0.1096262057532-04
18.00	0.2464899686958D+01	0.2464962756723+01	0.6306976472326-04
19.00	0.3407820425152D+01	0.3408223442336+01	0.4030171840324-03
20.00	0.5327896816591D+01	0.5331855223459+01	

21.00 0.1155393207572D+02 0.1168137380031+02
 22.00 0.1921699249630D+03 0.6847966834558+02
 23.00 0.3119852767022D+18 -0.8687629546482+01
 00.00 0.3278192015012+261 0.4588037824984 +01

6.4 System implementation

This work also captured the process of localising faulty nodes with a view of detecting the location and faulty node identification, the location, the diagram in Figure 10 shows a software for node status, the green circle represents healthy nodes, while the red circle represents faulty nodes, when the mouse cursor is positioned on the circle in the Figure 10 it will automatically highlight or pop up the address of the location. The map of the location for deployment of Sensors is shown in figure 10 for a single hop while for a Multi-hop the diagram in figure 3.3 which follows a Artificial Neural Network represented by $Fnet = w_1x = w_1x_1 + \dots + \dots + w_nx_n \dots$

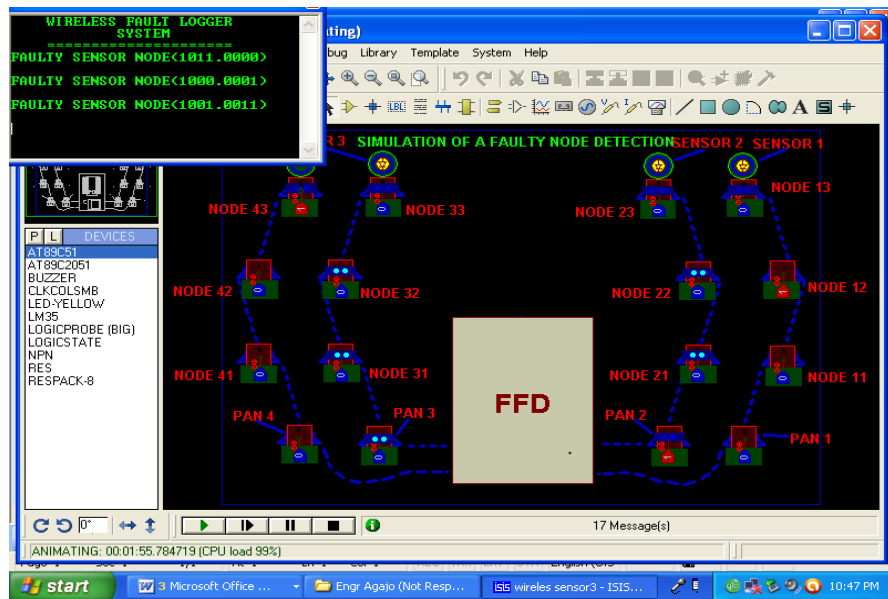

Figure 8: Linear route representation of Node network

Figure 8 is a Kalman’s filter principle as represented by equation 5 [31,32].

$$y_i(k) = f_i(y_i(k - 1), y_i(k - 2), \dots, y_i(k - m)) \dots \dots \dots 5$$

The method of Detecting faulty nodes involves both software and artificial neural network as shown figure 8. A Proteus design is used localize faulty node using node addresses and also it will prompt you to another page that shows the location where the faulty node is, but in the case of intermediate node the case is different a

method of Artificial Neural Network is adopted in figure 8 [35,36].

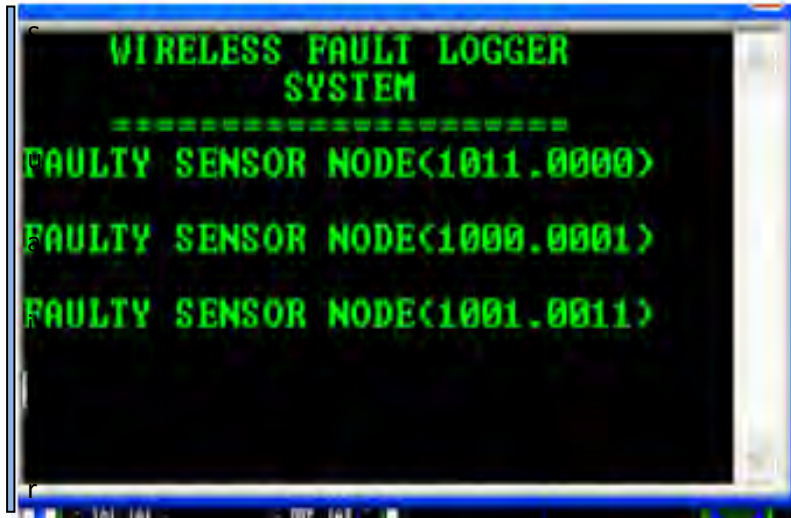

Figure 9: Fault Sensor Node Logger using ISIS

The process involve having to create a software interface that will identify location of each node for single hop routine process, as shown in figure 10 when a node goes faulty , the green spot changes to red.

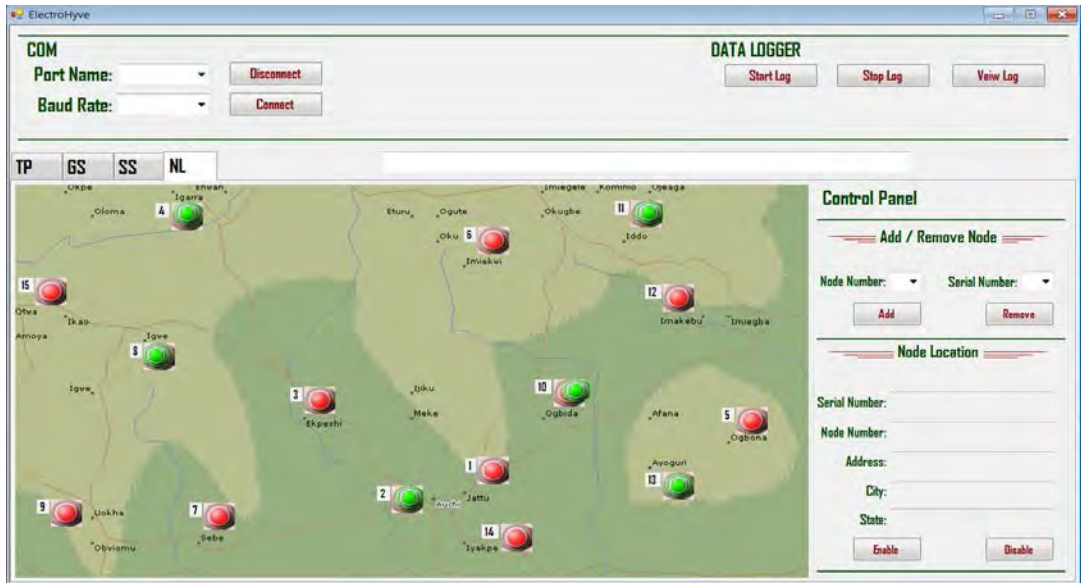

Figure 10: Faulty /Healthy Node Location on Map

7. Implementing dynamic graph plotter for adaptive monitoring

In implementing the dynamic graph plotter a concept was developed where $T = \text{time}$, which the variable is been measured and $V = \text{variable measured}$., the point on the graph template that makes up the matrix is (V,t) , Figure 10 becomes active by changing to red,. A stream of event is then generated sequentially for a period of time as

shown in figure 11 and 12 respectively.

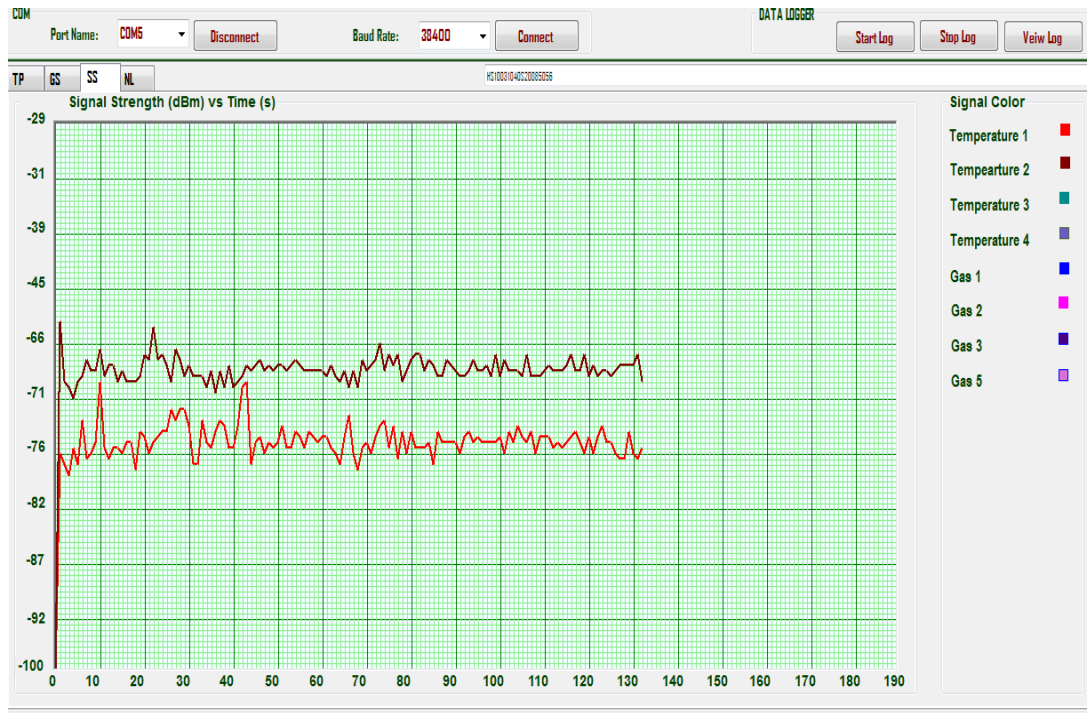

Figure 11: C Sharp Version of Temperature Plotter

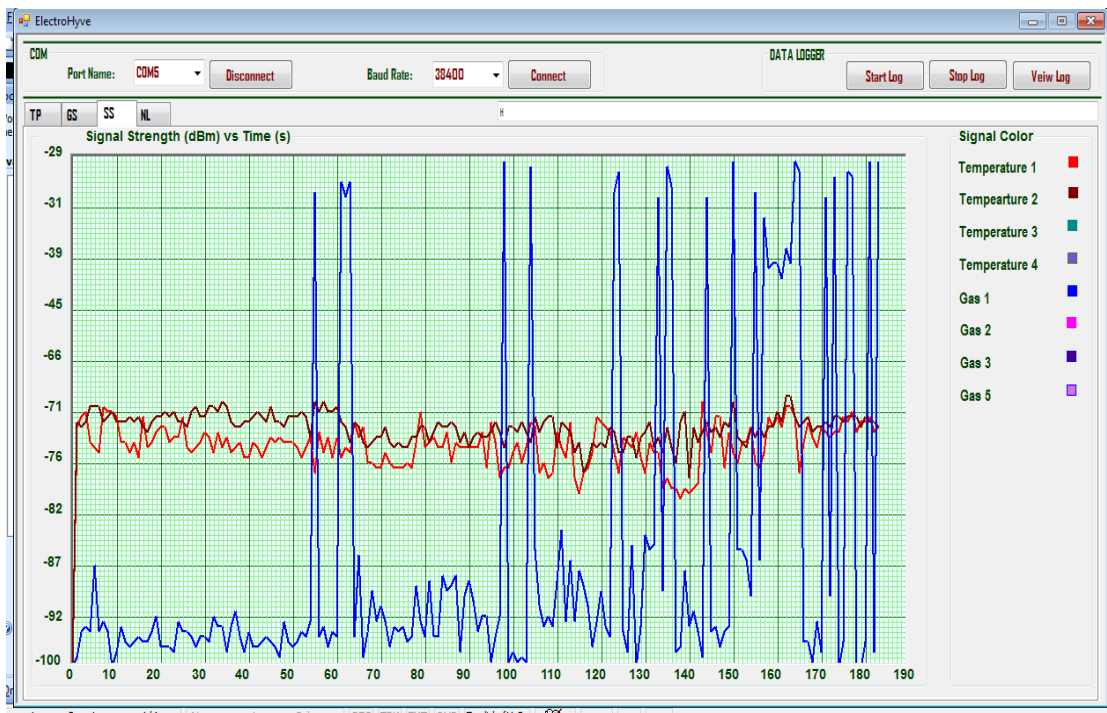

Figure 12: C Sharp Version of Temperature Plotter 2

The result of the of transmitted data is seen in practical software interface USING C-Sharp program in figure 11 and 12 , as can be seen from the interface The Port Name Chosen for this work is COM 4 , and Baud rate is 38400, the Start log commences the logging process while the Stop log discontinues the process, view log take one to the Database where all Data are kept, TP stand for temperature, while GS represent Gas, SS stand for signal strength and NL stand for node location. From the figure in 3.6 and 3.7 it can be seen that The result from the plot shows that the Sensor nodes were able to capture temperature range of between 25⁰C to 51⁰C while the result of the CO emission shows an interval of 0.01g/m³ to 30.0 g/m³

One also advanced the work by incorporating a Graphical Liquid Crystal Display (GLCD) shown in figure 13., a hand held device to enhance flexibility and smartness.

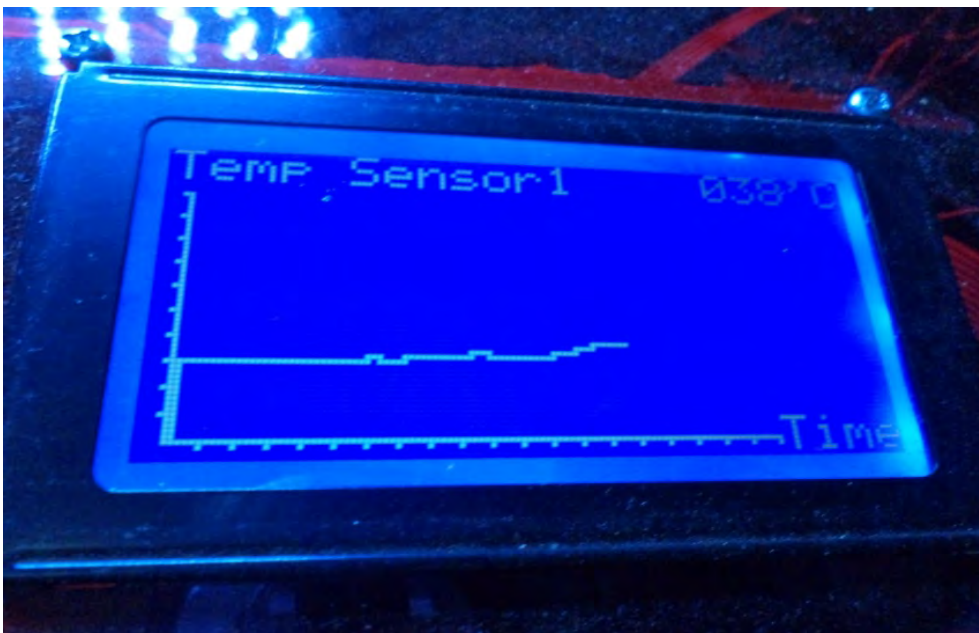

Figure: 13: Graphical Liquid Crystal Display

The variable has been displayed by the graph in the monitor.

8. Validation of data

The graph shows a dynamic graph plotter for sensor 1, sensor 2, and sensor 3 as deployed to various site, with the aid of the sensors, one of the sensor node graph result is shown in figure 3.7 .In validating the data one came up with a statistical tool used in analyzing this. A comparison between data transmitted at the source and data received at the destination was carried out, a ranking test was performed to validate the data received by checking their level of correlation

Thus

$$r = 1 - \frac{\sum (d)^2}{n(n-1)} = 0.9825$$

The value of r shows a very strong relationship between the transmitted data obtained for temperature and received data, this shows a strong correlating between the two.

9. Discussion of result

Faulty node detection and localization was also realized, this was achieved by coming up with an algorithm that logically considers the receive signal strength value of -100 dbm as threshold, The result from the Visual Basic plot shows that the Sensor nodes were able to capture temperature range of between 25⁰C to 51⁰C while the result for the CO emission shows an interval of 0.01g/m³ to 30.0 g/m³. A comparison between data transmitted at source and data received at the destination (sink) was carried out, a ranking test was used to validate the data received, a 0.9325 correlation value was obtained which shows a high level of integrity of 93.25%. one main limitation was that this work did not take into account altitude in the map, but basically the level of strength in signal and surface put together should make up for that to some extent, but from the observation the signal strength level was not uniform with inter sensor surface as a result of different in altitude.

10. Conclusion

This work completely unveils the extreme use of Wireless Sensor Network in monitoring hidden data that could not be easily detected by some conversational techniques. This use of dynamic graphical software in monitoring real-time activity, it is a step ahead as well. Faulty node detection is one of the outstanding breakthrough in this work, we can now localize our node as it can indicate its position on the map citing location, and also re assign addresses for the replaced node.

References

- [1] Gbenga Owojaiye Yichuang Sun,(2012), Focal design issues affecting the deployment of wireless sensor networks for pipeline monitoring, Elsevier Volume 11, Issue 3, May 2013, Pages 1237–125
- [2] I.F.Akyildiz, W. Su, Y. Sankarasubramaniam E. Capirci, “Wireless Sensor Networks: a Survey”, Computer Networks, Vol 38, N. 4, March 2002.
- [3] Khan et al., 2011] Khan, S. A., Daachi, B., and Djouani, K. (2011). Overcoming localization errors due to node power drooping in a wireless sensor network. International Journal of Electronics and Telecommunications, 57(3):341–346
- [4] D. Estrin, L. Girod, G. Pottie, M. Srivastava, “Instrumenting the world with wireless sensor networks”, Proc. Acoustics, Speech, and Signal Processing, vol. 4, pp. 2033–2036, 2001.
- [5] Habib F. Rashvand , Jose M. Alcaraz, Distributed Sensor Network Practice and Application, John Wiley & Sons Ltd Publication 2012 pp81-91 2012
- [6] Regalia and Wang, 2010 Regalia, P. and Wang, J. (2010). On distance reconstruction for sensor network

- localization. In IEEE International Conference on Acoustics, Speech and Signal Processing, pages 2866–2869.
- [7] Nishant Jakhar, Rainu Nandal (2012) , A Secure Data Aggregation Approach In Wsn Using Ann, Ijreas Pp 2-4.
- [8] Khan et al., 2010a] Khan, S. A., Daachi, B., and Djouani, K. (2010a). Enhanced sensor localization through compensation of battery level decay. Fifth International Conference on Broadband and Biomedical Communications 2010 (IB2Com), pages 1–5.
- [9] Romer, K.; Mattern, F., "The design space of wireless sensor networks," *Wireless Communications, IEEE*, vol.11, no.6, pp. 54-61, Dec. 2004.
- [10] Seo Hyun Oh, Chan O. Hong, Yoon Hwa Choi (2012) Application of fuzzy inference systems to detection of faults in wireless sensor networks Elsevier Volume 94, 1 Pp 111-120
- [11] A. Mainwaring, D. Culler, J. Polastre, R. Szewczyk, and J. Anderson, "Wireless sensor networks for habitat monitoring," *Proc. ACM international workshop on Wireless sensor networks and applications*, pp. 88–97, 2002.
- [12] C. Hartung, R. Han, C. Seielstad, and S. Holbrook, "FireWxNet: a multitiered portable wireless system for monitoring weather conditions in wildland fire environments," *Proc. International conference on Mobile systems, applications and services*, pp. 28–41, 2006.
- [13] K. Yunseop; R.G. Evans; W.M. Iversen, "Remote Sensing and Control of an Irrigation System Using a Distributed Wireless Sensor Network," *IEEE Trans. on Instrumentation and Measurement*, vol.57, no.7, pp.1379-1387, July 2008
- [14] A. Baggio, "Wireless sensor networks in precision agriculture", in *Proc. ACM Workshop on Real-World Wireless Sensor Networks (REALWSN 2005)*, Stockholm, Sweden, June 2005.
- [15] M. Bertocco; G. Gamba; A. Sona; S. Vitturi., "Experimental Characterization of Wireless Sensor Networks for Industrial Applications," *IEEE Trans. on Instrumentation and Measurement*, vol.57, no.8, pp.1537-1546, Aug. 2008
- [16] S. Antifakos, F. Michahelles, and B. Schiele, "Proactive Instructions for Furniture Assembly," in *Proc. Ubicomp 2002 Gothenburg, Sweden*, Sept. 2002.
- [17] K.B. Lee; M.E. Reichardt, "Open standards for homeland security sensor networks," *IEEE Magazine on Instrumentation & Measurement*, vol.8, no.5, pp. 14-21, Dec. 2005 19
- [18] A.M. Mielke; S.M. Brennan; M.C. Smith; D.C. Torney; A.B. Maccabe; JF. Karlin, "Independent sensor networks," *IEEE Magazine on Instrumentation & Measurement*, vol.8, no.2, pp. 33-37, Jun 2005

- [19] W. Dai-Hua; L. Wei-Hsin, "Wireless transmission for health monitoring of large structures," IEEE Trans. On Instrumentation and Measurement, vol.55, no.3, pp. 972-981, June 2006-
- [20] H. Baldus, K. Klabunde, and G. Muesch, "Reliable Set-Up of Medical Body-Sensor Networks," in Proc. EWSN 2004 Berlin, Germany, Jan. 2004.
- [21] ON World Inc, "Wireless Sensor Networks – Growing Markets, Accelerating Demands", July 2005, available at <http://www.onworld.com/html/wirelessensorsrprt2.htm>.
- [22] Embedded WiSeNTs Consortium, "Embedded WiSeNTs Research Roadmap (Deliverable 3.3)", available at www.embedded-wisents.org.
- [23] IEEE Pervasive Computing, "Energy Harvesting and Conservation", Vol. 4, Issue 1, Jan-Mar. 2005.
- [25] Alippi, C.; Galperti, C., "An Adaptive System for Optimal Solar Energy Harvesting in Wireless Sensor Network Nodes," Circuits and Systems I: Regular Papers, IEEE Transactions on , vol.55, no.6, pp.1742-1750, July 2008.
- [26] Geoffrey K. Ottman, Heath F. Hofmann, Archin C. Bhatt and George A. Lesieutre "Adaptive Piezoelectric Energy Harvesting Circuit for Wireless Remote Power Supply" in IEEE Transactions on Power Electronics, Vol. 17, No. 5, September 2002 pp. 669 - 776.
- [27]"Energy Harvesting Projects", Collections of articles on IEEE Pervasive Computing, pp. 69-71, January-March 2005.
- [28] J.A. Paradiso and T. Starner, "Energy scavenging for mobile and wireless electronics" in IEEE Pervasive Computing, Vol.4, January-March 2005, pp. 18-27.
- [29] S. Roundy, E.S. Leland, J. Baker, E. Carleton, E. Reilly, E. Lai, B. Otis, J.M. Rabaey, P.K. Wright and V. Sundararajan, "Improving power output for vibration-based energy scavengers" in IEEE Pervasive Computing, Vol.4, January-March 2005, pp.